

MTO-2283L Open Frame Solenoids

Plunger Weight 可動鐵心重量:700g
 Total Weight 總重量:1385g

Shown Energized 通電狀態
 UNIT 單位:mm

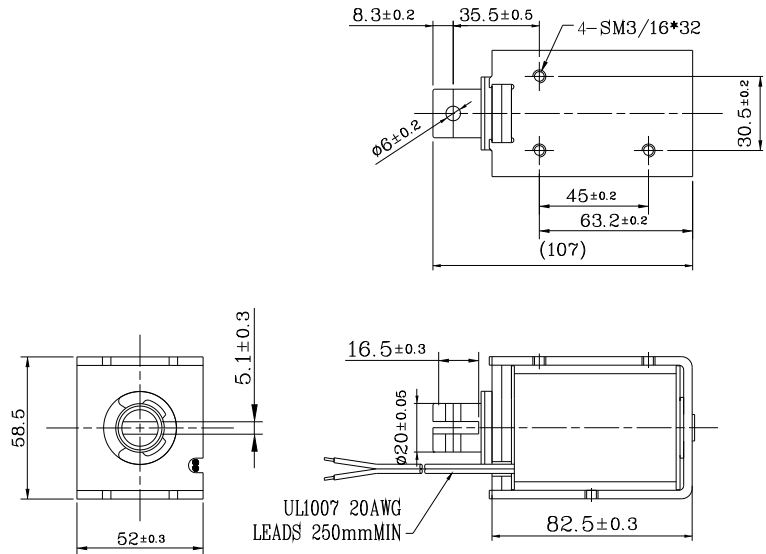
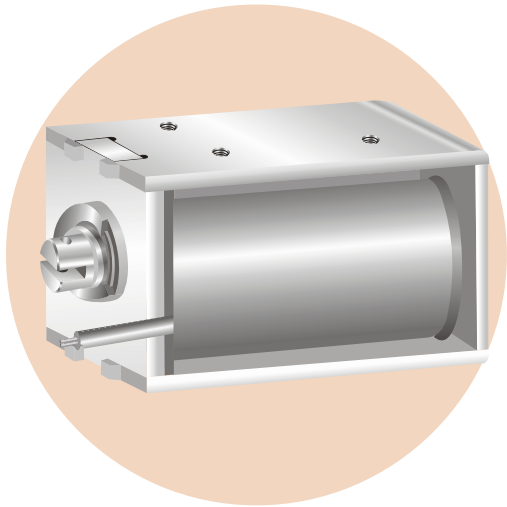

COIL DATA線圈資料

$\text{Duty Cycle (\%)} = \frac{\text{"ON" time}}{\text{"ON" time} + \text{"OFF" time}} \times 100\%$ 作動週期 (%) = $\frac{\text{On時間}}{\text{ON時間} + \text{OFF時間}} \times 100\%$			Continuous(100%) 連續(100%)	Or less(50%) 間斷(50%)	Or less(25%) 間斷(25%)	Or less(10%) 間斷(10%)
MAX. "on" time in seconds 最大 ON 時間 (秒)			∞	250	120	40
Watts at 20°C 瓦特數 (w) (在20°C)			14.5	29	58	145
Ampere-turns at 20°C At值 (在20°C)			1996	2828	3993	6323
Type No.	Resistance(20°C) Ω ±10%	No. Turns	Volts DC (電壓)			
型號	阻值(Ω)±10%	繞線圈數				
MTO-2283LAA	2.5	832	6	8.5	12	19
	9.9	1685	12	17	24	38
	39.7	3265	24	34	48	76
	159	6525	48	68	96	152

行程 / 吸引力
STROKE Vs FORCE

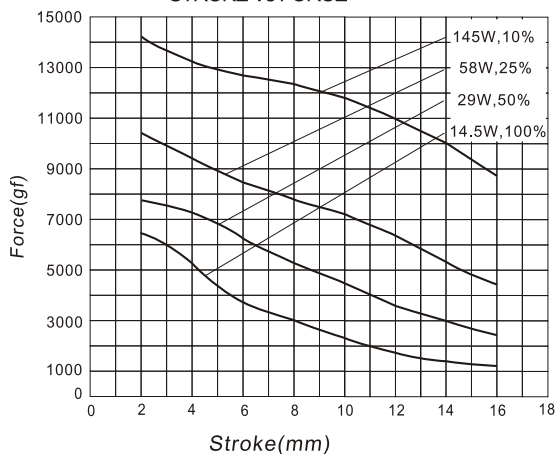

安-匝 / 吸引力
AMPERE-TURNS Vs FORCE

